

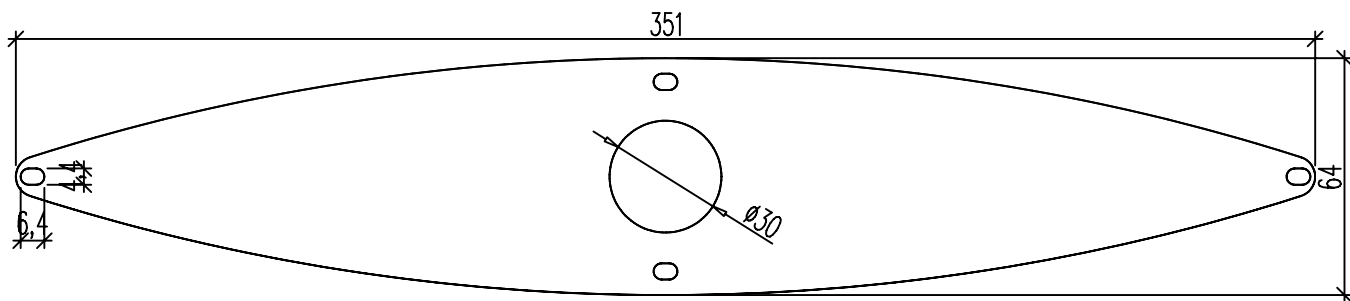

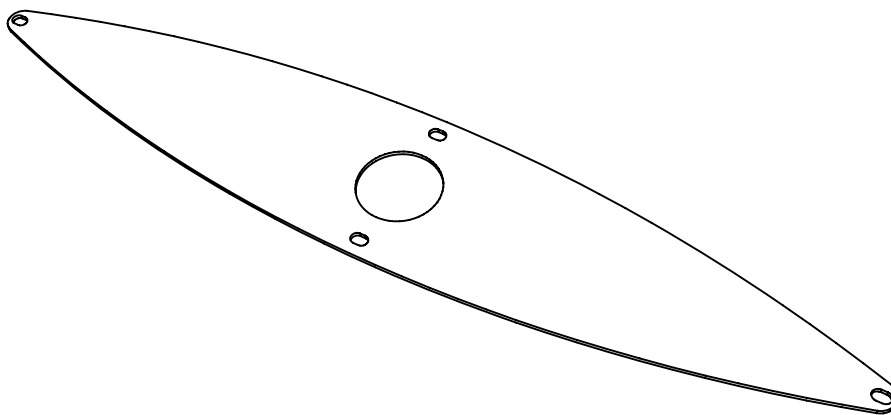

Draufsicht
(Maßstab 0,5:1)



ISO-Ansicht



Auftrags-Nr.:				Maßangaben in mm		Norm		Maßstab: 0,5 : 1		Gewicht:	
								Werkstoff: Aluminium		Modellnummer:	
								Zeichnungs-Nr.:		Index: 0	
				Datum	Name		Benennung / Bezeichnung: DD-350-R Internet: www.mll-gmbh.de e-mail: mll@mll-gmbh.de  Blatt:				
				Gezeichnet							
				Kontrolliert							
				Freigabe							
				Konstruiert durch:		Linke					
				MLL GmbH Liebigstr. 26 22113 Hamburg Tel:040-736-79 40-0 Fax:040-736-79 40-29							
Status	Änderungen	Datum	Name	Ursprung:				Ersatz für:		Ersetzt durch:	
										A4	

