

# Gummiprofile zum Einnuten Nr. 526 + 634 (Türen/Fenster)

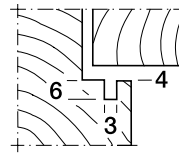

Nr. 526



## HEBGO-Hohlkammerdichtung, Silikon-Qualität

Rollen à 50 m

Kleinpackungen à 7 m

**526.1** schwarz  
**526.2** braun  
**526.7** grau  
**526.9** weiss

**526.1k** schwarz  
**526.2k** braun  
**526.7k** grau  
**526.9k** weiss



Nr. 634



## HEBGO-Lippendichtung, Silikon-Qualität

Rollen à 50 m

Kleinpackungen à 7 m

**634.1** schwarz  
**634.2** braun  
**634.7** grau  
**634.9** weiss

**634.1k** schwarz  
**634.9k** weiss

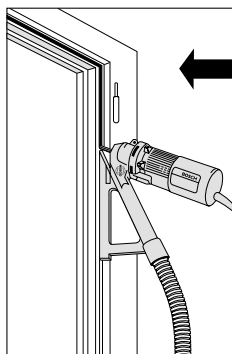
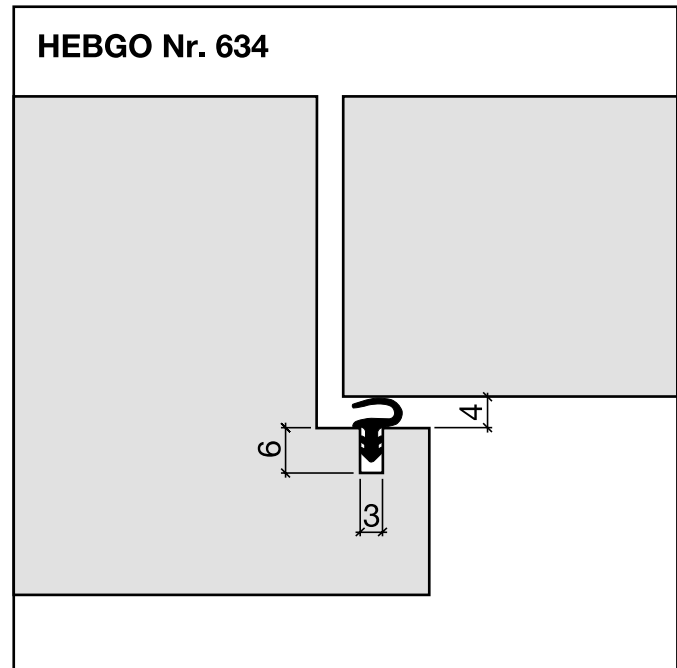
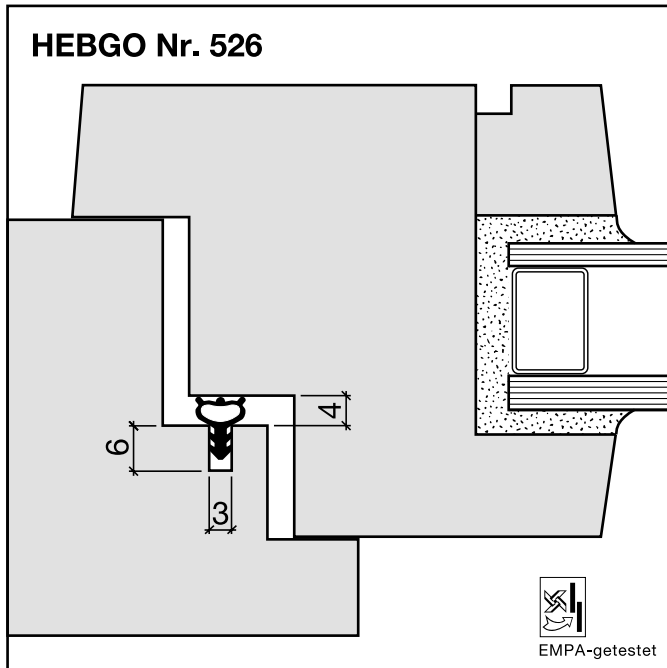

Sanierungssystem mit HEBGO-Doppelnutfräse siehe Seite H. 01

# Dichtungsprofil Nr. 131 (Türen/Fenster)

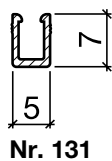

## HEBGO-Halteprofil aus Aluminium

Lagerlänge 5250 mm (☼ = 50)

**131.0** blank



## HEBGO-Hohlkammerdichtung, Silikon-Qualität

Rollen à 50 m

Kleinpackungen à 7 m

**526.1** schwarz  
**526.2** braun  
**526.7** grau  
**526.9** weiss

**526.1k** schwarz  
**526.2k** braun  
**526.7k** grau  
**526.9k** weiss



## HEBGO-Lippendichtung, Silikon-Qualität

Rollen à 50 m

Kleinpackungen à 7 m

**634.1** schwarz  
**634.2** braun  
**634.7** grau  
**634.9** weiss

**634.1k** schwarz  
**634.9k** weiss

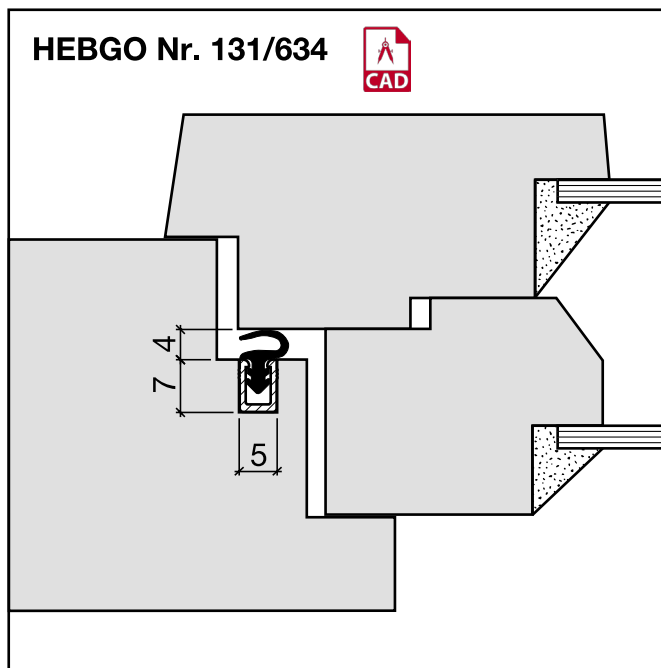
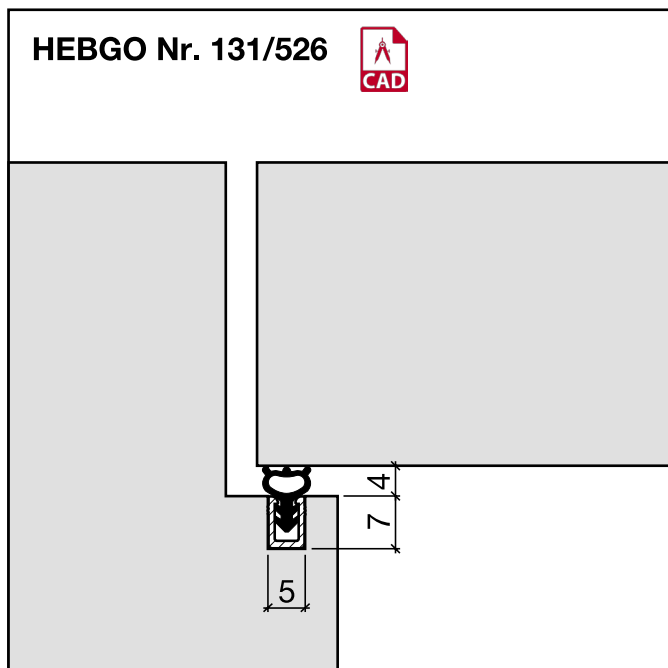

# Sanierungsprofil Nr. 121 (Fenster)

Vorgelochtes Aluminiumprofil zum Annageln (mit verzinkten Stiften 1,4 x 25 mm)

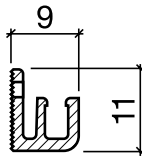

Nr. 121

## HEBGO-Halteprofil aus Aluminium

vorgelocht 2,0 mm, alle 150 mm

Lagerlänge 5250 mm (☼ = 20)

- 121.0** blank
- 121.1** farblos eloxiert
- 121.2** bronzefarbig eloxiert

## HEBGO-Hohlkammerdichtung, Silikon-Qualität

Rollen à 50 m

Kleinpackungen à 7 m



Nr. 526



- |                      |                       |
|----------------------|-----------------------|
| <b>526.1</b> schwarz | <b>526.1k</b> schwarz |
| <b>526.2</b> braun   | <b>526.2k</b> braun   |
| <b>526.7</b> grau    | <b>526.7k</b> grau    |
| <b>526.9</b> weiss   | <b>526.9k</b> weiss   |

## HEBGO-Lippendichtung, Silikon-Qualität

Rollen à 50 m

Kleinpackungen à 7 m



Nr. 634



- |                      |                       |
|----------------------|-----------------------|
| <b>634.1</b> schwarz | <b>634.1k</b> schwarz |
| <b>634.2</b> braun   |                       |
| <b>634.7</b> grau    |                       |
| <b>634.9</b> weiss   | <b>634.9k</b> weiss   |

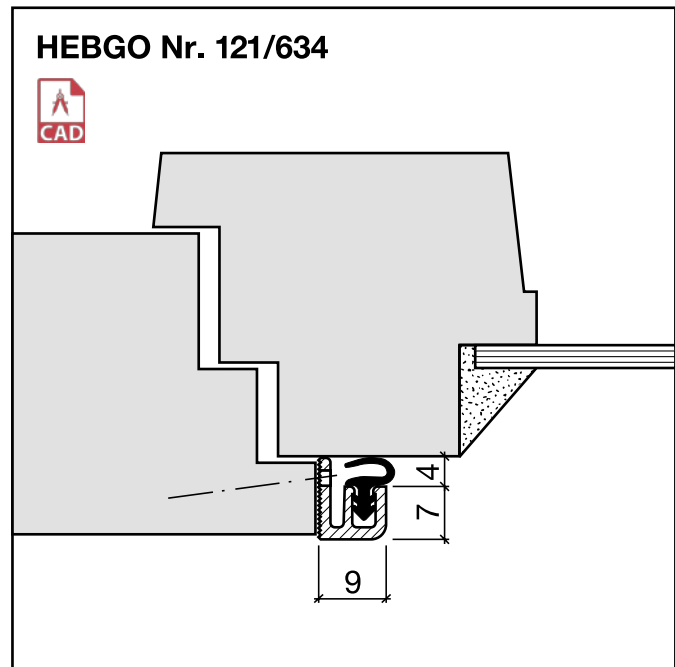
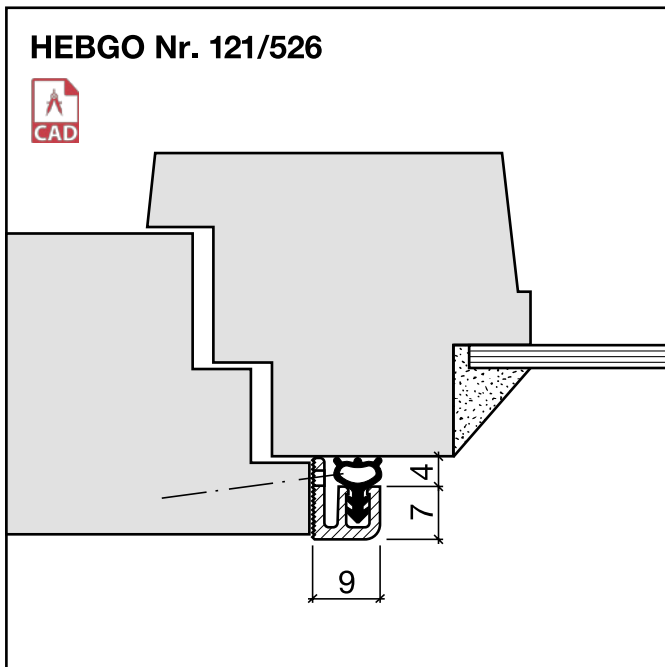

a-Wert (Luftdurchlässigkeit) siehe Seite H. 09

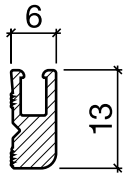

Nr. 129

**HEBGO-Sanierungsprofil aus Aluminium**

Lagerlänge 5250 mm (☼ = 20)

- 129.0** blank
- 129.1** farblos eloxiert
- 129.2** bronzefarbig eloxiert

**HEBGO-Hohlkammerdichtung, Silikon-Qualität**

Rollen à 50 m

Kleinpackungen à 7 m



Nr. 526



- |                      |                       |
|----------------------|-----------------------|
| <b>526.1</b> schwarz | <b>526.1k</b> schwarz |
| <b>526.2</b> braun   | <b>526.2k</b> braun   |
| <b>526.7</b> grau    | <b>526.7k</b> grau    |
| <b>526.9</b> weiss   | <b>526.9k</b> weiss   |

**HEBGO-Lippendichtung, Silikon-Qualität**

Rollen à 50 m

Kleinpackungen à 7 m



Nr. 634



- |                      |                       |
|----------------------|-----------------------|
| <b>634.1</b> schwarz | <b>634.1k</b> schwarz |
| <b>634.2</b> braun   |                       |
| <b>634.7</b> grau    |                       |
| <b>634.9</b> weiss   | <b>634.9k</b> weiss   |

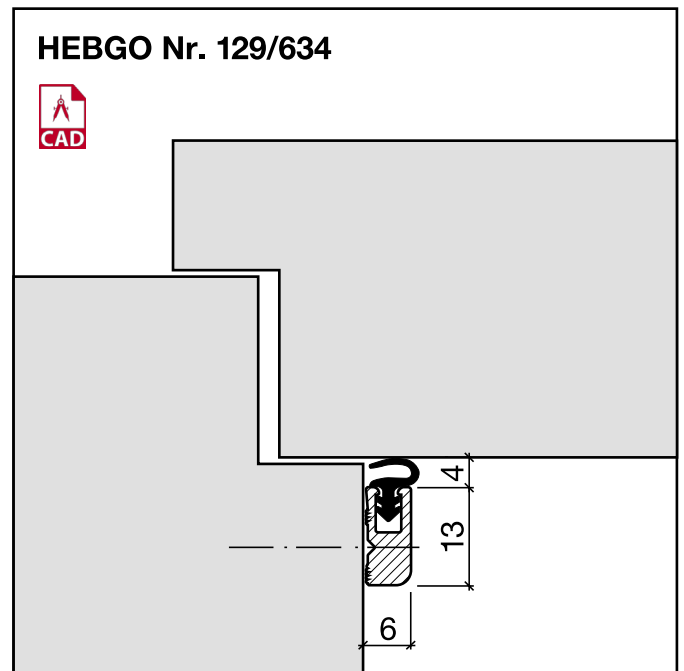
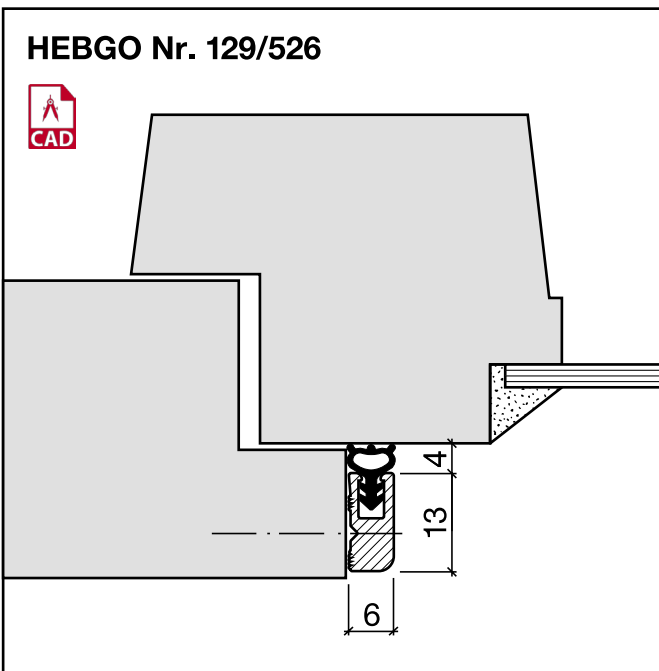

# Sanierungsprofil Nr. 126 (Türen)

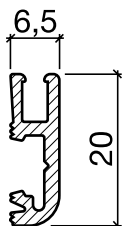

Nr. 126

## HEBGO-Sanierungsprofil aus Aluminium

Lagerlänge 5250 mm (☼ = 20)

- 126.0** blank
- 126.1** farblos eloxiert
- 126.2** bronzefarbig eloxiert

## HEBGO-Hohlkammerdichtung, Silikon-Qualität

Rollen à 50 m

Kleinpackungen à 7 m



Nr. 526



- |                      |                       |
|----------------------|-----------------------|
| <b>526.1</b> schwarz | <b>526.1k</b> schwarz |
| <b>526.2</b> braun   | <b>526.2k</b> braun   |
| <b>526.7</b> grau    | <b>526.7k</b> grau    |
| <b>526.9</b> weiss   | <b>526.9k</b> weiss   |

## HEBGO-Lippendichtung, Silikon-Qualität

Rollen à 50 m

Kleinpackungen à 7 m



Nr. 634



- |                      |                       |
|----------------------|-----------------------|
| <b>634.1</b> schwarz | <b>634.1k</b> schwarz |
| <b>634.2</b> braun   |                       |
| <b>634.7</b> grau    |                       |
| <b>634.9</b> weiss   | <b>634.9k</b> weiss   |

## HEBGO-Befestigungs-Set "Holz" (für 1 Lagerlänge)

- 901.9** 1 Tüte: 25 Delrin-Knöpfe  
25 Spanplattenschrauben, SK, 2,7 x 16 mm

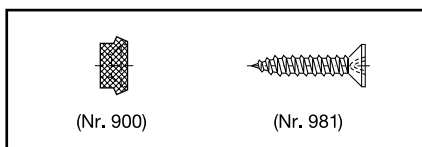

Nr. 901

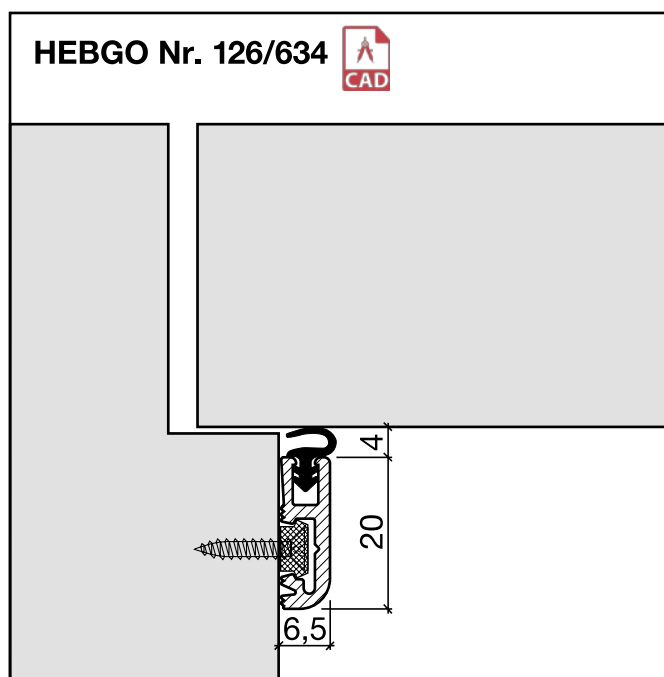
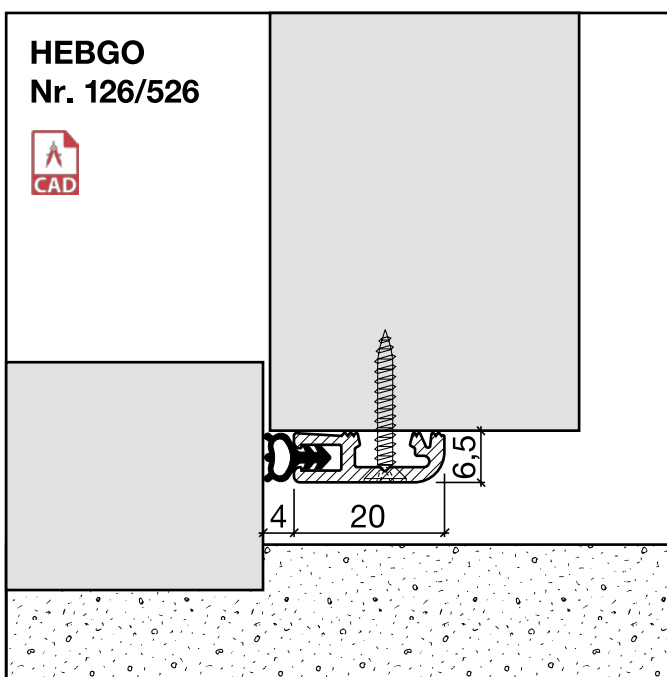

Schalldämmwerte siehe Seite H. 11



a-Wert (Luftdurchlässigkeit) siehe Seite H. 09

# Sanierungsprofil Nr. 124 (aufgedoppelteTüre)



Schalldämmwerte siehe Seite H. 12

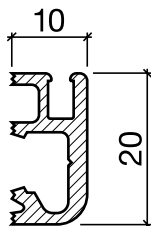

Nr. 124

## HEBGO-Sanierungsprofil aus Aluminium

Lagerlänge 5250 mm (☼ = 20)

- 124.0** blank
- 124.1** farblos eloxiert
- 124.2** bronzefarbig eloxiert



Nr. 526



## HEBGO-Hohlkammerdichtung, Silikon-Qualität

Rollen à 50 m

Kleinpackungen à 7 m

- |                      |                       |
|----------------------|-----------------------|
| <b>526.1</b> schwarz | <b>526.1k</b> schwarz |
| <b>526.2</b> braun   | <b>526.2k</b> braun   |
| <b>526.7</b> grau    | <b>526.7k</b> grau    |
| <b>526.9</b> weiss   | <b>526.9k</b> weiss   |



Nr. 634



## HEBGO-Lippendichtung, Silikon-Qualität

Rollen à 50 m

Kleinpackungen à 7 m

- |                      |                       |
|----------------------|-----------------------|
| <b>634.1</b> schwarz | <b>634.1k</b> schwarz |
| <b>634.2</b> braun   |                       |
| <b>634.7</b> grau    |                       |
| <b>634.9</b> weiss   | <b>634.9k</b> weiss   |

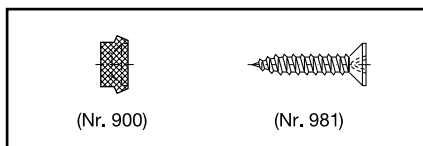

Nr. 901

## HEBGO-Befestigungs-Set "Holz" (für 1 Lagerlänge)

- 901.9** 1 Tüte: 25 Delrin-Knöpfe  
25 Spanplattenschrauben, SK, 2,7 x 16 mm

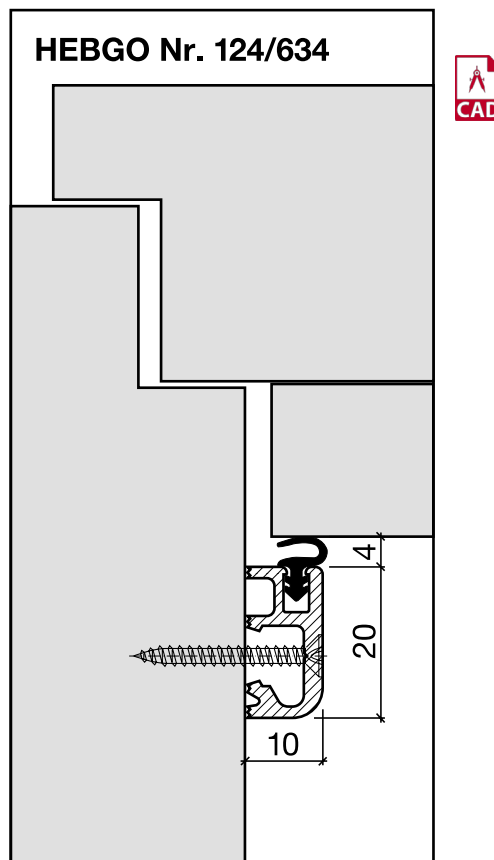
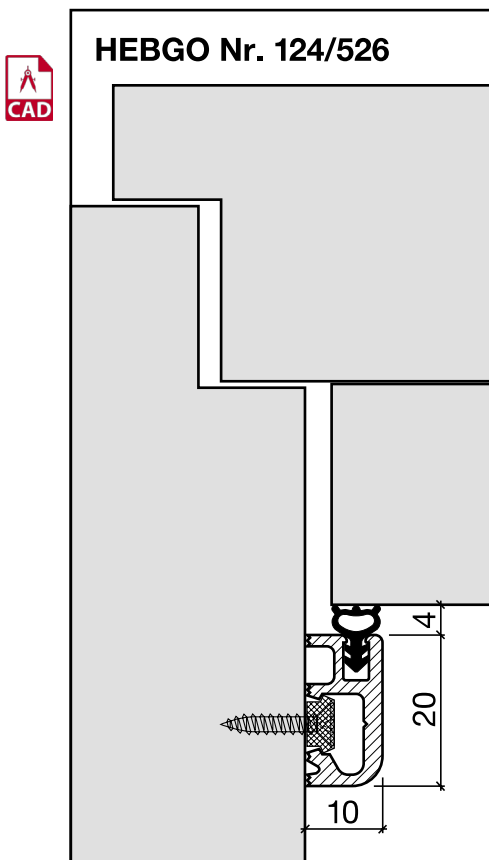

# Dichtungsprofil Nr. 126 für Metallbau (Sanierung)

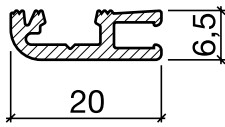

Nr. 126

## HEBGO-Sanierungsprofil aus Aluminium

Lagerlänge 5250 mm (☼ = 20)

- 126.0** blank
- 126.1** farblos eloxiert
- 126.2** bronzefarbig eloxiert

## HEBGO-Hohlkammerdichtung, Silikon-Qualität

Rollen à 50 m

Kleinpackungen à 7 m



Nr. 526



- |                      |                       |
|----------------------|-----------------------|
| <b>526.1</b> schwarz | <b>526.1k</b> schwarz |
| <b>526.2</b> braun   | <b>526.2k</b> braun   |
| <b>526.7</b> grau    | <b>526.7k</b> grau    |
| <b>526.9</b> weiss   | <b>526.9k</b> weiss   |

## HEBGO-Lippendichtung, Silikon-Qualität

Rollen à 50 m

Kleinpackungen à 7 m



Nr. 634



- |                      |                       |
|----------------------|-----------------------|
| <b>634.1</b> schwarz | <b>634.1k</b> schwarz |
| <b>634.2</b> braun   |                       |
| <b>634.7</b> grau    |                       |
| <b>634.9</b> weiss   | <b>634.9k</b> weiss   |

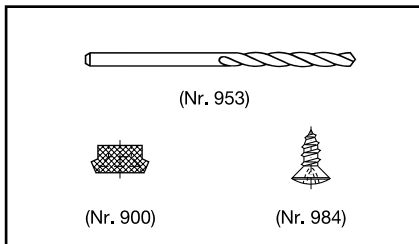

Nr. 902

## HEBGO-Befestigungs-Set "Metall" (für 1 Lagerlänge)

- 902.9** 1 Tüte: 25 Delrin-Knöpfe  
25 Blechschrauben, LSK, 2,9 x 6,5 mm  
1 Bohrer HSS Ø 2,4 mm

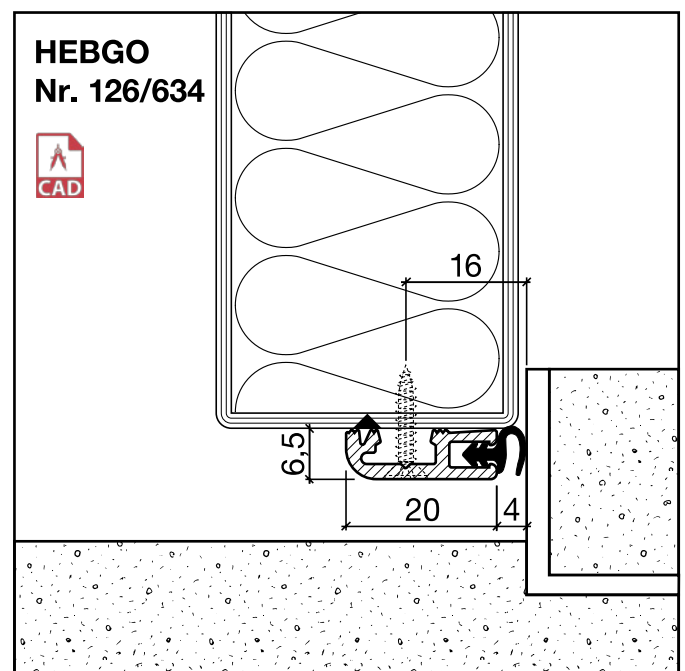
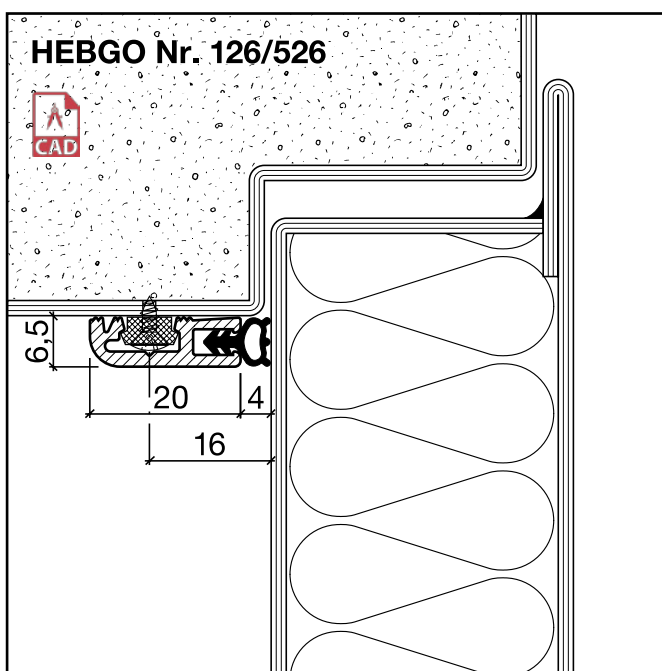

a-Wert (Luftdurchlässigkeit) siehe Seite H. 09

# Dichtungsprofil Nr. 136 für Metallbau (Sanierung)

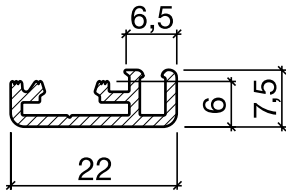

Nr. 136

## HEBGO-Sanierungsprofil aus Aluminium

Lagerlänge 5250 mm (☼ = 20)

- 136.0** blank
- 136.1** farblos eloxiert
- 136.2** bronzefarbig eloxiert



Nr. 526



## HEBGO-Hohlkammerdichtung, Silikon-Qualität

Rollen à 50 m

Kleinpackungen à 7 m

- |                      |                       |
|----------------------|-----------------------|
| <b>526.1</b> schwarz | <b>526.1k</b> schwarz |
| <b>526.2</b> braun   | <b>526.2k</b> braun   |
| <b>526.7</b> grau    | <b>526.7k</b> grau    |
| <b>526.9</b> weiss   | <b>526.9k</b> weiss   |



Nr. 634



## HEBGO-Lippendichtung, Silikon-Qualität

Rollen à 50 m

Kleinpackungen à 7 m

- |                      |                       |
|----------------------|-----------------------|
| <b>634.1</b> schwarz | <b>634.1k</b> schwarz |
| <b>634.2</b> braun   |                       |
| <b>634.7</b> grau    |                       |
| <b>634.9</b> weiss   | <b>634.9k</b> weiss   |

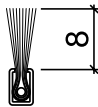

Nr. 751

## HEBGO-Bürstendichtung, Nylon-Faser

Lagerlänge 5250 mm

- 751.1** schwarz

## HEBGO-Befestigungs-Set "Metall" (für 1 Lagerlänge)

- 902.9** 1 Tüte: 25 Delrin-Knöpfe
- 25 Blechschrauben, LSK, 2,9 x 6,5 mm
- 1 Bohrer HSS Ø 2,4 mm

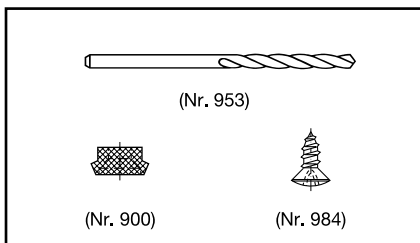

Nr. 902

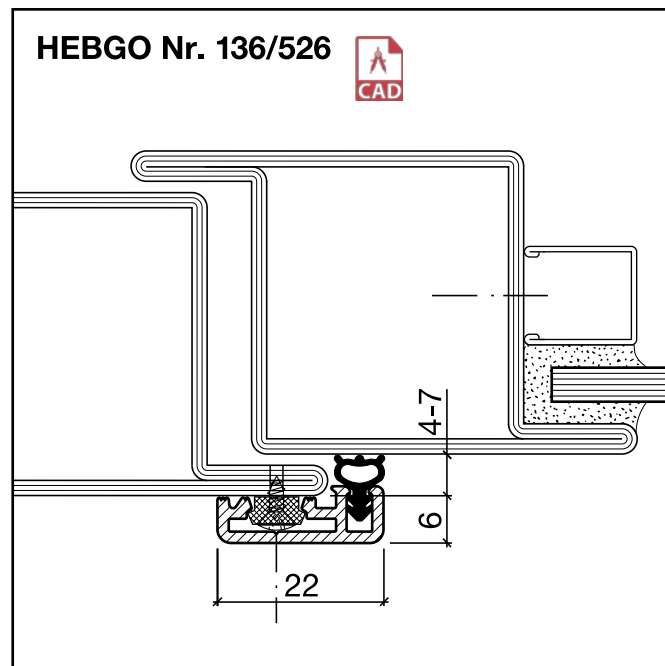
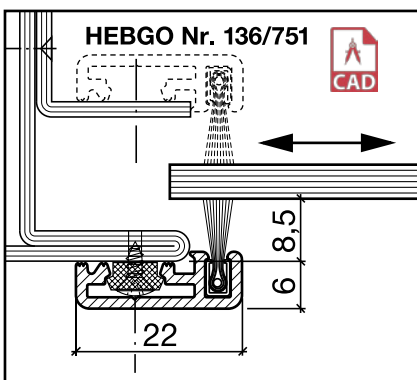
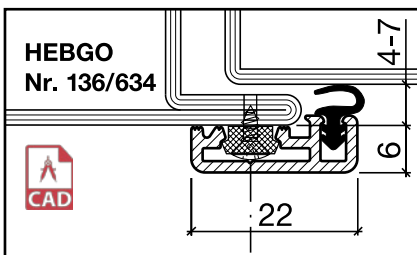



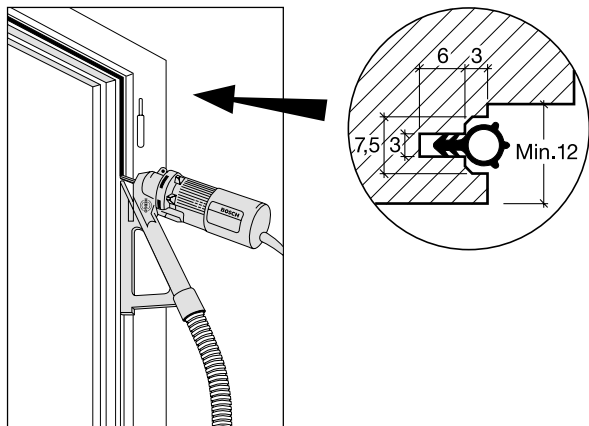

### Sanierungsvorgang:

1. Fenster aushängen.
2. Doppelnuten in einem Arbeitsgang fräsen.
3. Nuten imprägnieren.
4. Gummiprofile eindrücken.
5. Fenster einhängen.

### Vorteil:

- Kein Verziehen der Flügel, das Profil kann in die Nute einfedern.
- Wenig Montagestaub dank Späneabsaugung.
- Nuten können im Rahmenfalz bis in die Ecke gefräst werden.
- Stufenfräser.
- Zufriedene Kunden, die teure Heizwärme bleibt im Haus.

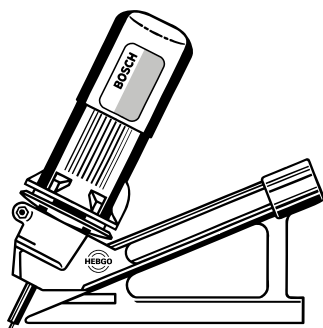

Nr. 965

### HEBGO-Doppelnutfräse (Spannzange 8,0 mm) kompletter Arbeitskoffer

- 965.0** 1 Koffer
- mit Bosch-Maschine, 27000 Touren, 220 V, 500 W, Kabel 5 m
  - mit Fräserführung
  - mit Absaugschlauch, Länge 3 m
  - mit Werkzeugset
  - ohne Fräser
- Verkauf nur durch den Fachhandel



Nr. 967

### HEBGO-Nutenfräser (Doppelnute 3/7,5 mm) Schaft Ø 8 mm, Vollhartmetall

- 967.0** 1 Stück

### HEBGO-Hohlkammerdichtung, Silikon-Qualität

Rollen à 50 m

Kleinpackungen à 7 m



Nr. 526



- |                      |                       |
|----------------------|-----------------------|
| <b>526.1</b> schwarz | <b>526.1k</b> schwarz |
| <b>526.2</b> braun   | <b>526.2k</b> braun   |
| <b>526.7</b> grau    | <b>526.7k</b> grau    |
| <b>526.9</b> weiss   | <b>526.9k</b> weiss   |

### HEBGO-Lippendichtung, Silikon-Qualität

Rollen à 50 m

Kleinpackungen à 7 m



Nr. 634



- |                      |                       |
|----------------------|-----------------------|
| <b>634.1</b> schwarz | <b>634.1k</b> schwarz |
| <b>634.2</b> braun   |                       |
| <b>634.7</b> grau    |                       |
| <b>634.9</b> weiss   | <b>634.9k</b> weiss   |



a-Wert (Luftdurchlässigkeit) siehe Seite H. 10