

6

5

4



3

2

1

### Vorderansicht

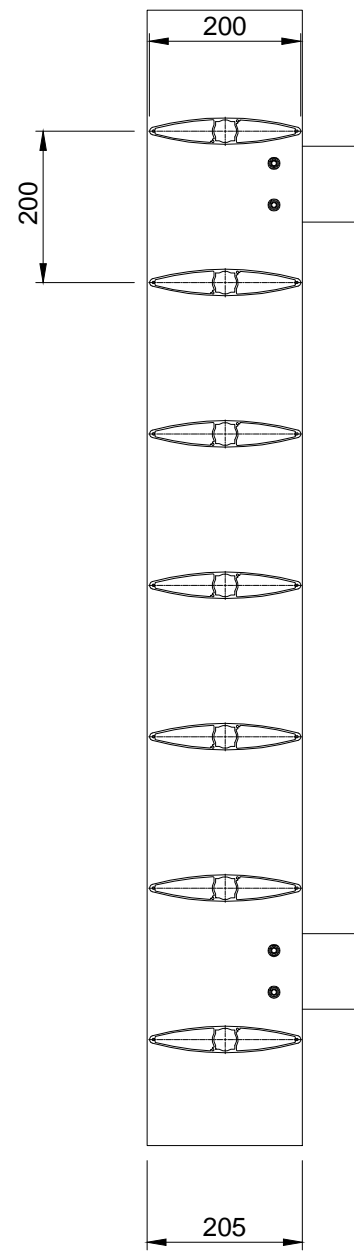

### Seitenansicht

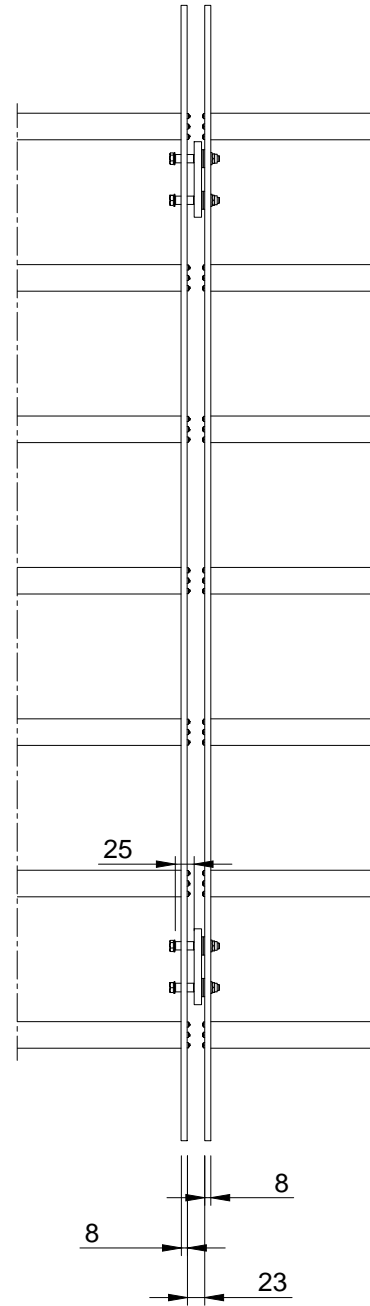

### ISO-Ansicht

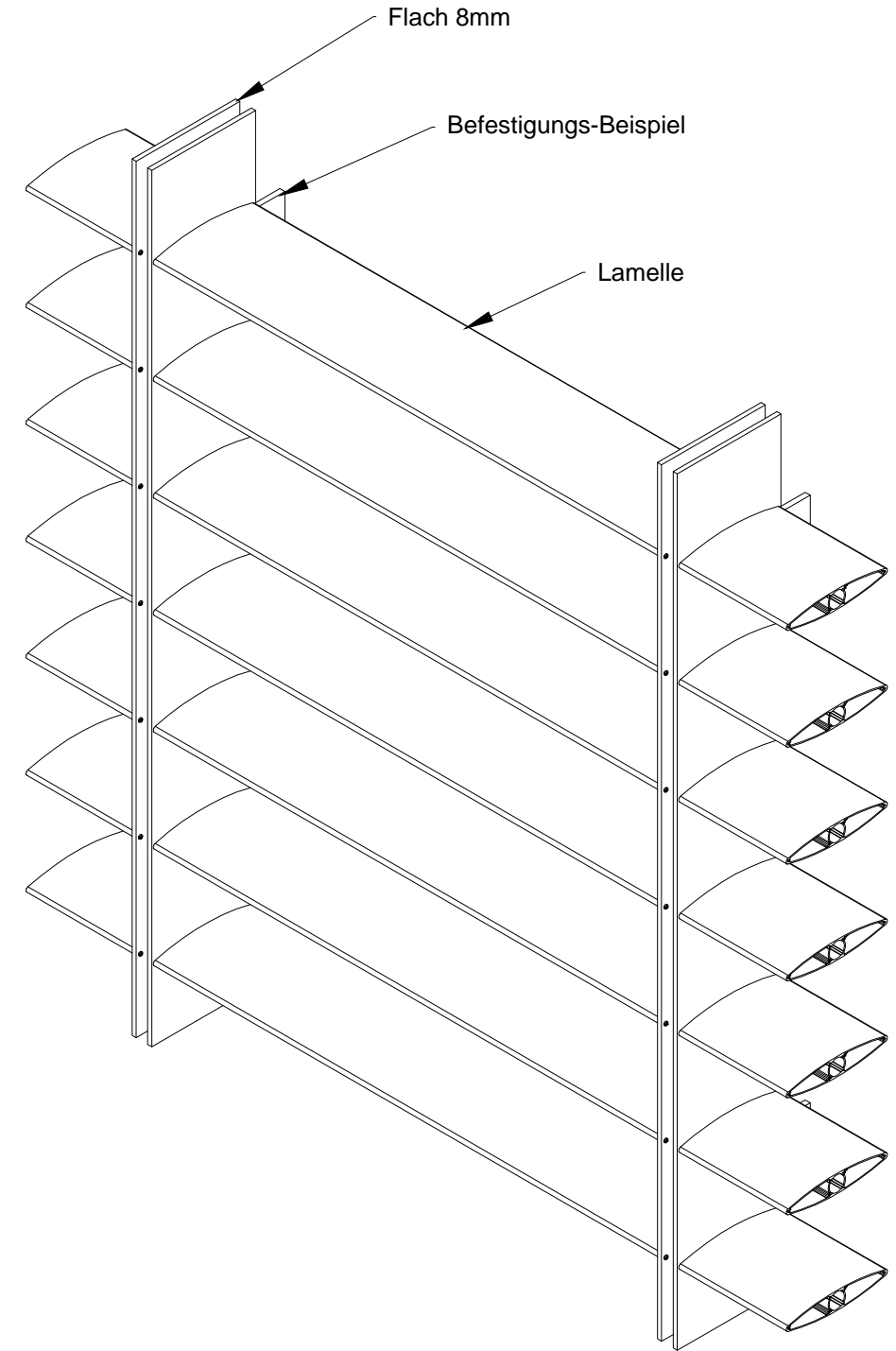

### Draufsicht

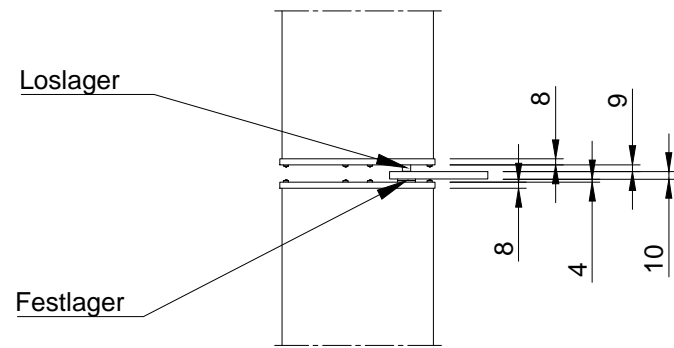

Auftrags-Nr.:		Maßangaben in mm		Norm		Maßstab: 1:10		Gewicht:	
						<b>Werkstoff: Aluminium</b>		Modellnummer:	
						Zeichnungs-Nr.:		Index:	
						<b>Benennung / Bezeichnung:</b>			
						<b>VS-H-200-KA-0</b>			
						Internet: <a href="http://www.mll-gmbh.de">www.mll-gmbh.de</a>		e-mail: <a href="mailto:mll@mll-gmbh.de">mll@mll-gmbh.de</a>	
								Blatt:	
								1	
								A3	
Status		Änderungen		Datum		Name		Ursprung:	
								Ersatz für:	
								Ersetzt durch:	

6

5

4



3

2

1

A