

6

5

4



3

2

1

Vorderansicht

Seitenansicht

ISO-Ansicht

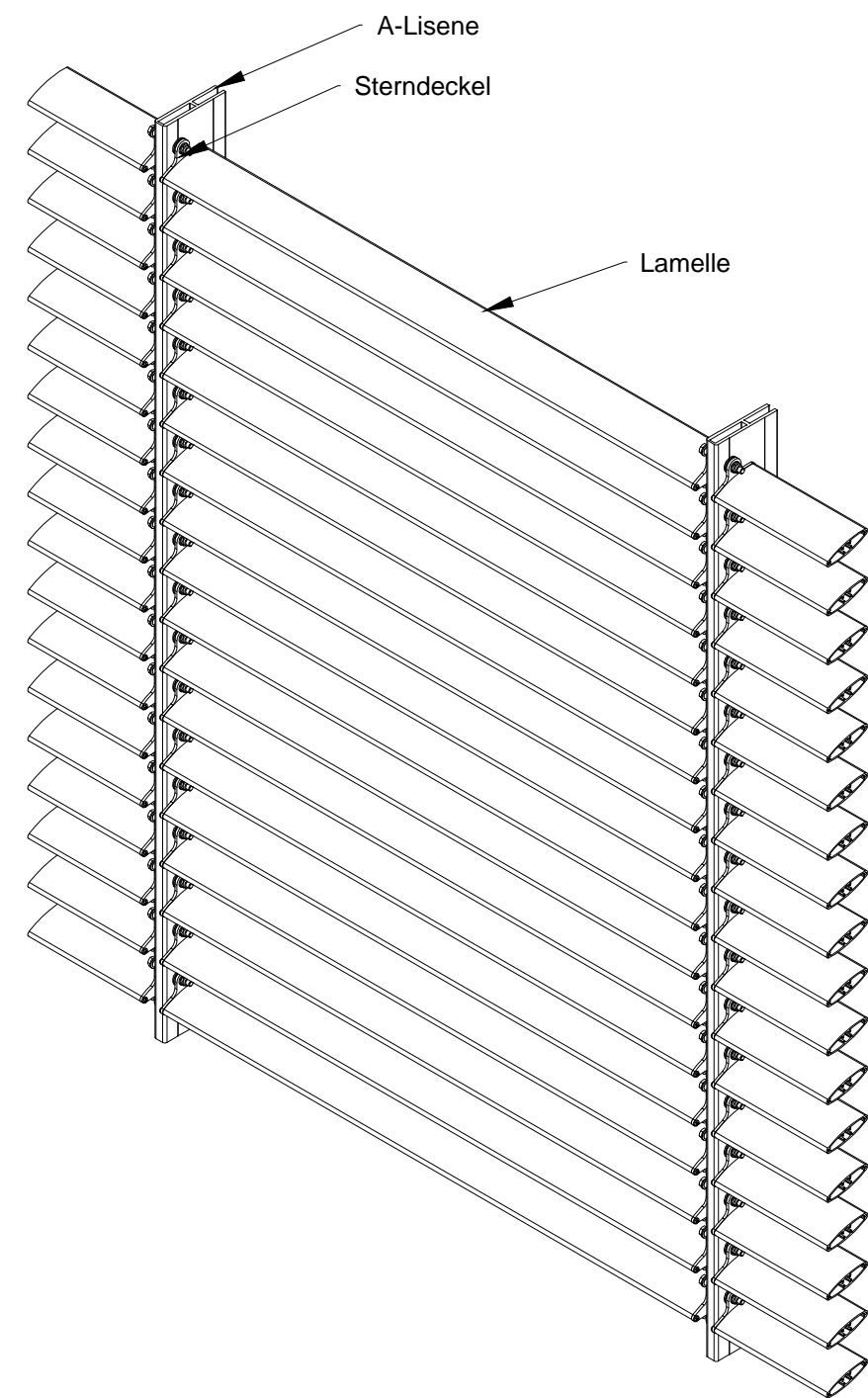
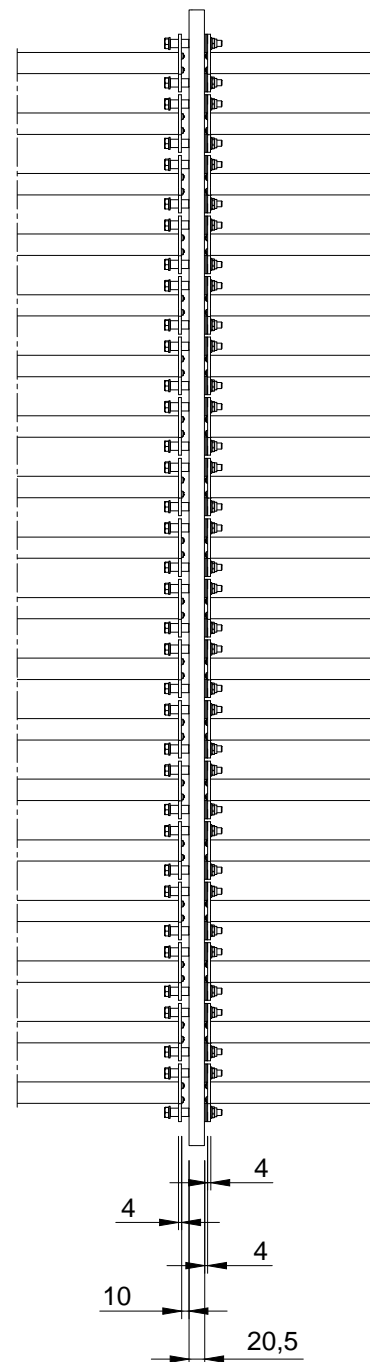
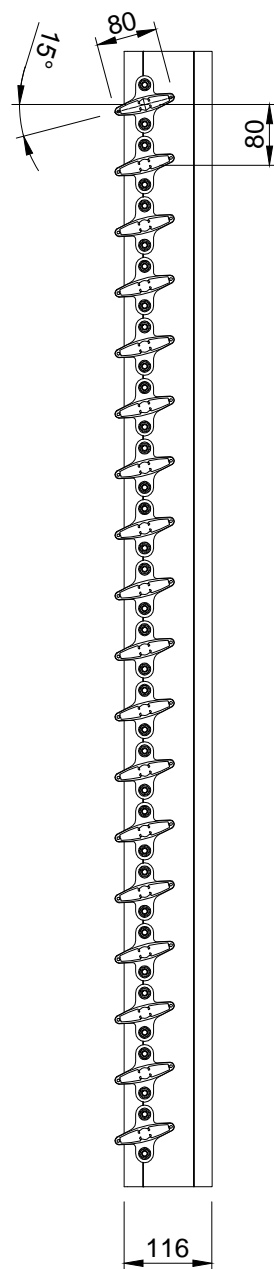

Draufsicht

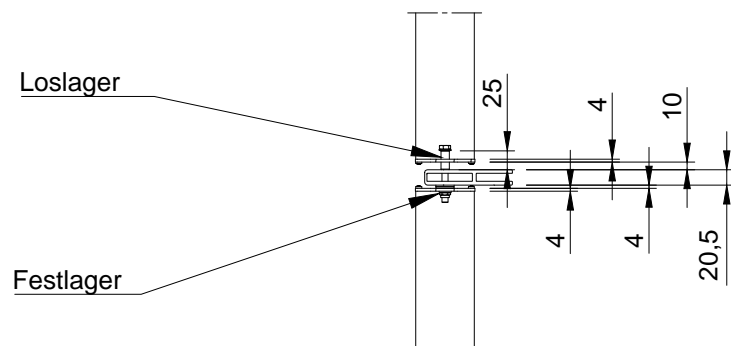

Auftrags-Nr.:		Maßangaben in mm		Norm		Maßstab: 1:10		Gewicht:	
						Werkstoff: Aluminium		Modellnummer:	
						Zeichnungs-Nr.:		Index:	
						Benennung / Bezeichnung:		 Blatt:	
						VS-H-080-SD-15			
						Internet: www.mll-gmbh.de		e-mail: mll@mll-gmbh.de	
						MLL GmbH Liebigstr. 26 22113 Hamburg Tel:040-736-79 40-0 Fax:040-736-79 40-29		1 A3	
						Konstruiert durch: MLL GmbH			
Status		Änderungen		Datum		Name		Ursprung:	
								Ersatz für:	
								Ersetzt durch:	

6

5

4



3

2

1

D

C

B

A

D

C

B

A